

HIGH VOLTAGE VIDEO AMPLIFIERS

DESCRIPTION

The BF457, BF458 and BF459 are silicon planar epitaxial NPN transistors in Jedec TO-126 plastic package. They are particularly intended for use as video output stages in colour and black and white TV receivers, class A output stages and drivers for horizontal deflection circuits. These transistors have been studied in order to guarantee the maximum resistance against flash over.

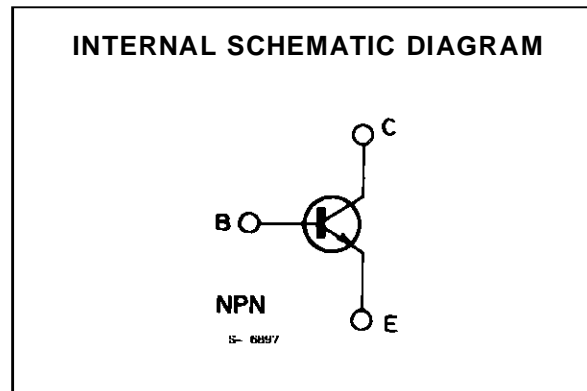
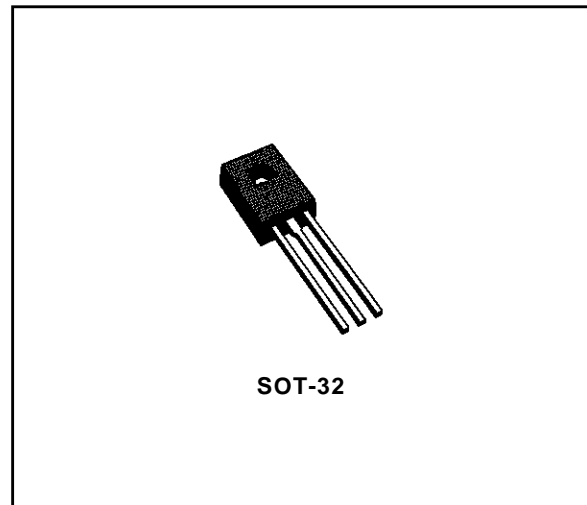

ABSOLUTE MAXIMUM RATINGS

Symbol	Parameter	Value			Unit
		BF 457	BF 458	BF 459	
V_{CBO}	Collector-base Voltage ($I_E = 0$)	160	250	300	V
V_{CEO}	Collector-emitter Voltage ($I_B = 0$)	160	250	300	V
V_{EBO}	Emitter-base Voltage ($I_C = 0$)	5			V
I_{CM}	Collector Peak Current	300			mA
I_{BM}	Base Peak Current	50			mA
P_{tot}	Total Power Dissipation at $T_{amb} \leq 25\text{ }^\circ\text{C}$ $T_{case} \leq 25\text{ }^\circ\text{C}$	1.25			W
		12.5			W
T_{stg}	Storage Temperature	- 55 to 150			$^\circ\text{C}$
T_j	Junction Temperature	150			$^\circ\text{C}$

BF457-BF458-BF459

THERMAL DATA

$R_{th\ j-case}$	Thermal Resistance Junction-case	Max	10	°C/W
$R_{th\ j-amb}$	Thermal Resistance Junction-ambient	Max	100	°C/W

ELECTRICAL CHARACTERISTICS ($T_{case} = 25\ ^\circ C$ unless otherwise specified)

Symbol	Parameter	Test Conditions	Min.	Typ.	Max.	Unit
I_{CBO}	Collector Cutoff Current ($I_E = 0$)	for BF 457 $V_{CB} = 100\ V$ for BF 458 $V_{CB} = 200\ V$ for BF 459 $V_{CB} = 250\ V$			50 50 50	nA nA nA
$V_{(BR)CEO}^*$	Collector-emitter Breakdown Voltage ($I_B = 0$)	$I_C = 10\ mA$	for BF 457 160 for BF 458 250 for BF 459 300			V V V
$V_{(BR)EBO}$	Emitter-base Breakdown Voltage ($I_C = 0$)	$I_E = 100\ \mu A$	5			V
$V_{CE(sat)}^*$	Collector-emitter Saturation Voltage	$I_C = 50\ mA$ $I_B = 10\ mA$			1	V
h_{FE}^*	DC Current Gain	$I_C = 30\ mA$ $V_{CE} = 10\ V$	30	80		
f_T	Transition Frequency	$I_C = 30\ mA$ $V_{CE} = 10\ V$		90		MHz
C_{re}	Reverse Capacitance	$I_C = 0$ $f = 1\ MHz$		4		pF
C_{oe}	Output Capacitance	$I_C = 0$ $f = 1\ MHz$		5		pF

* Pulsed : pulse duration = 300 μs , duty cycle = 1 %.

DC Current Gain.

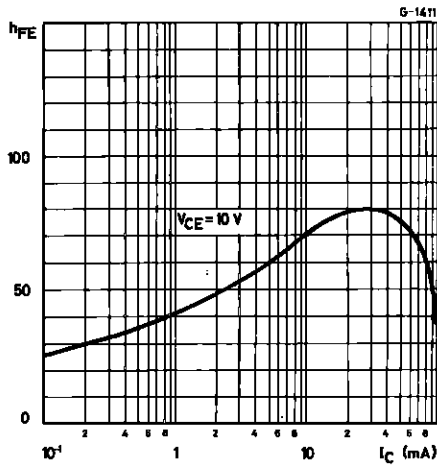

Collector-emitter Saturation Voltage.

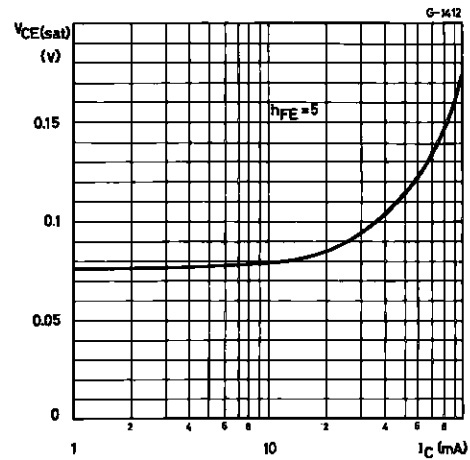

Transition Frequency.

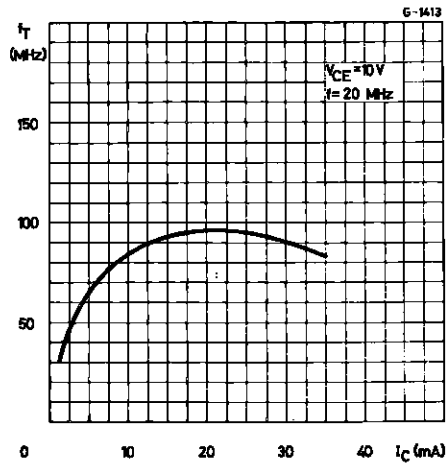

Output and Reverse Capacitance.

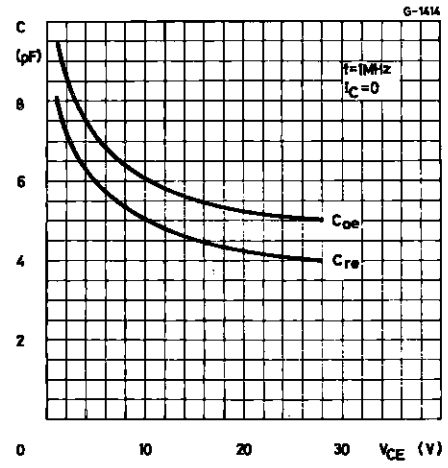

SOT-32 MECHANICAL DATA

DIM.	mm			inch		
	MIN.	TYP.	MAX.	MIN.	TYP.	MAX.
A	7.4		7.8	0.291		0.307
B	10.5		10.8	0.413		0.445
b	0.7		0.9	0.028		0.035
b1	0.49		0.75	0.019		0.030
C	2.4		2.7	0.04		0.106
c1		1.2			0.047	
D		15.7			0.618	
e		2.2			0.087	
e3		4.4			0.173	
F		3.8			0.150	
G	3		3.2	0.118		0.126
H			2.54			0.100

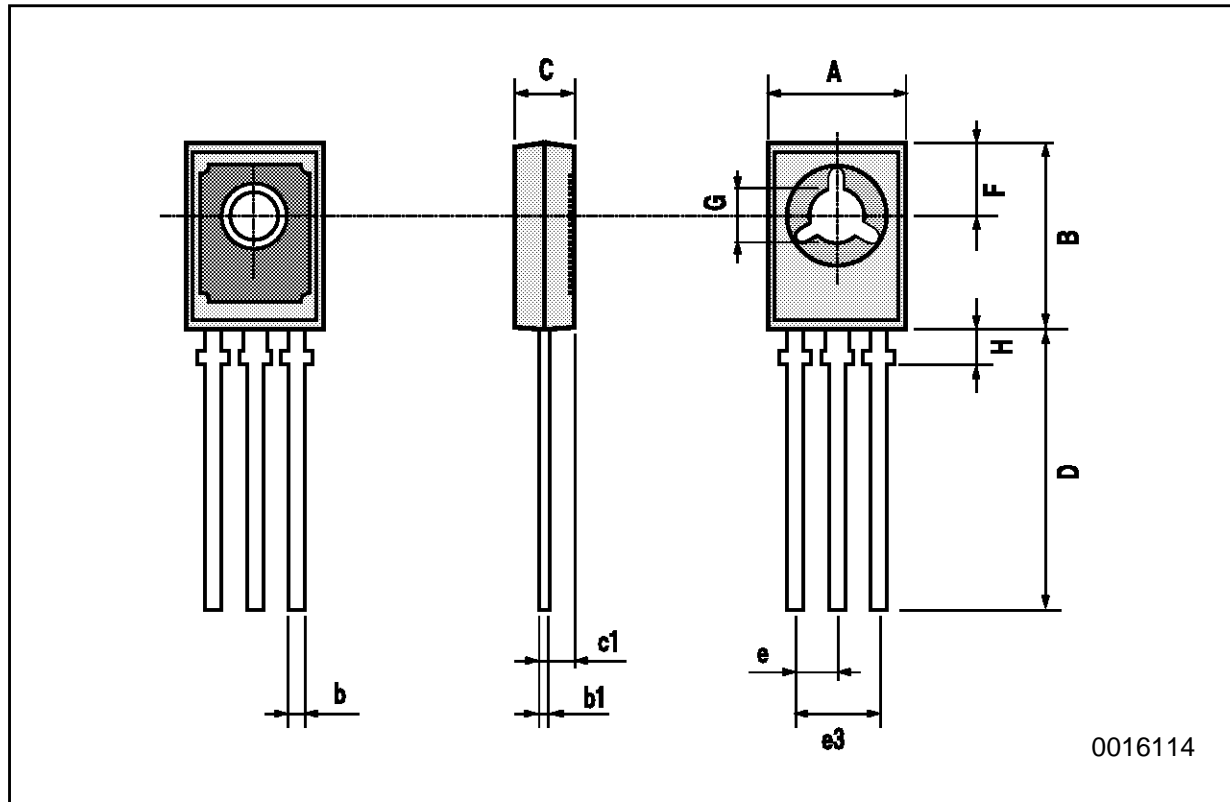

0016114

Information furnished is believed to be accurate and reliable. However, SGS-THOMSON Microelectronics assumes no responsibility for the consequences of use of such information nor for any infringement of patents or other rights of third parties which may result from its use. No license is granted by implication or otherwise under any patent or patent rights of SGS-THOMSON Microelectronics. Specifications mentioned in this publication are subject to change without notice. This publication supersedes and replaces all information previously supplied. SGS-THOMSON Microelectronics products are not authorized for use as critical components in life support devices or systems without express written approval of SGS-THOMSON Microelectronics.

© 1994 SGS-THOMSON Microelectronics - All Rights Reserved

SGS-THOMSON Microelectronics GROUP OF COMPANIES

Australia - Brazil - France - Germany - Hong Kong - Italy - Japan - Korea - Malaysia - Malta - Morocco - The Netherlands -
Singapore - Spain - Sweden - Switzerland - Taiwan - Thailand - United Kingdom - U.S.A